

ISO VIEW
DO NOT SCALE

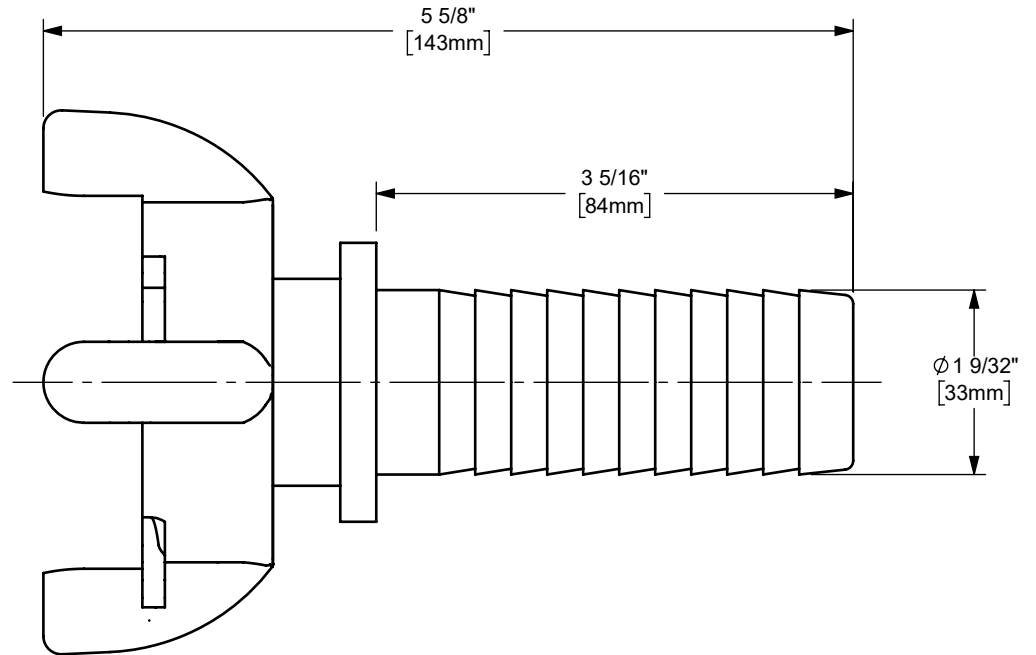

NOTE(S):

- 1) MUST USE SAFETY CLIPS.
- 2) WASHER NOT SHOWN.
- 3) SEE WEBSITE FOR WASHERS AND ALTERNATE SAFETY CLIPS.

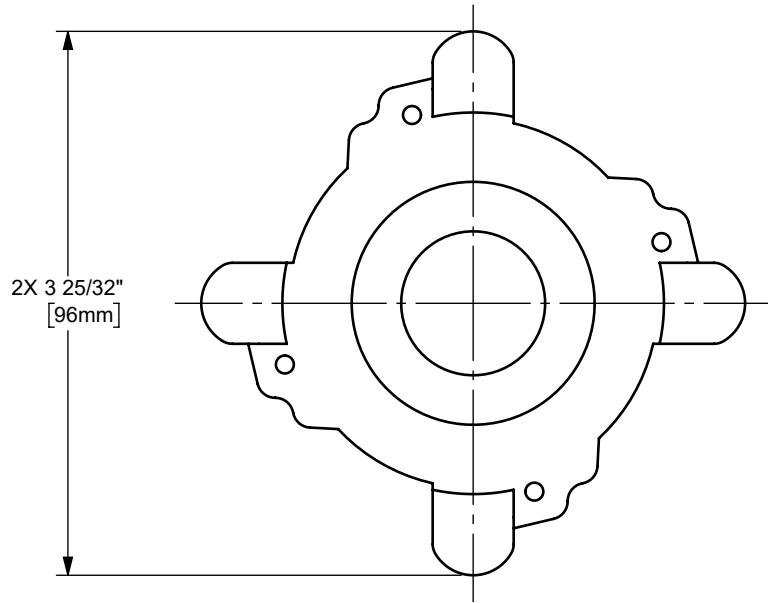

The Right Connection™

dixonvalve.com

2	AC1	AIR KING™ SAFETY CLIP	STEEL	1
1	AWR14	4-LUG WASHER	RUBBER	1
ITEM NO.	REPLACEMENT PART NUMBER	DESCRIPTION	MATERIAL	QTY.

PROPRIETARY AND CONFIDENTIAL

This drawing is owned by Dixon Valve & Coupling Co. and shall be returned upon demand. It is loaned on condition that it shall not be copied or reproduced or submitted to others without the owners consent. In accepting it subject to this condition the recipient further agrees that this drawing or any design detail or concept disclosed herein shall not be used in any way detrimental to or in competition with the owner. If the recipient does not agree to the terms of this agreement they shall return this drawing immediately. The information contained in this drawing is subject to change without notice.

DIXON U.S.A.

THE RIGHT CONNECTION™

TITLE: 4-LUG AIR KING™ WITH 1 1/4" HOSE SHANK

MATERIAL: SEE BOM

PART NUMBER: **AM16**

DO NOT SCALE THIS DRAWING